

LUGNA

FORM & FUNCTION



ASSEMBLY INSTRUCTIONS

Built-in Wardrobe Kit

LUGNA understands the importance of timeless style and practical durability for a home's form and function. Our European-inspired collection is simple and easy to use, with five modern colours that complement any style and space. LUGNA's modular system allows for endless configurations and additions, with various-sized cabinets, drawers, shelving, and hinged doors that can be combined to create a bespoke look on any budget. Whether you're looking for something modern and sleek or classic and elegant, LUGNA has something for everyone.



SCAN for
more info



⚠ WARNING

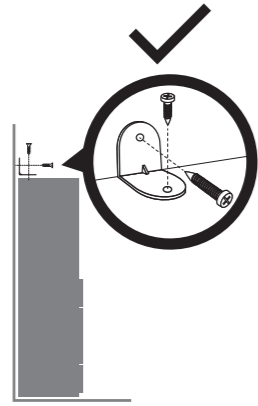

Children have died from furniture tipover.

- ALWAYS secure this furniture with an anchor device.
- NEVER allow children to stand, climb or hang on drawers, doors or shelves.
- Never open more than one drawer at a time.
- Place heavy items down low.

NEVER put a TV on this furniture.



What you will need

Tape Measure, Builders Square, Multi Function saw, Planner, Circular Saw, Sawhorses, Battery Driver, Battery Drill, Drills, Hammer, Chisel, Spirit Level, Caulking gun, Gap Filler.

Built-in Wardrobe Kit

These instructions cover the installation of all 6 wardrobe configurations shown below. Choose the info that is appropriate for your package.

Suits openings 1500-1800mm

1

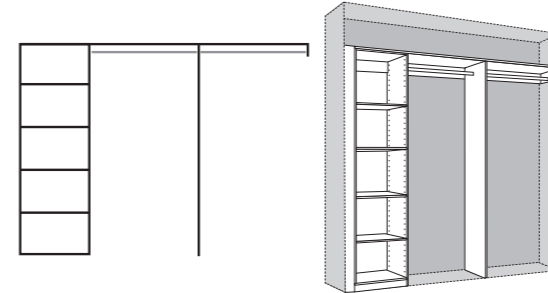

2

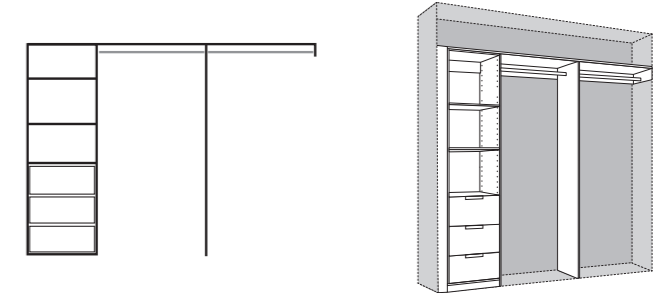

Suits openings 1800-2100mm

3

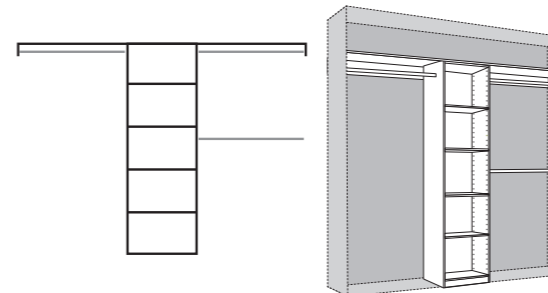

4

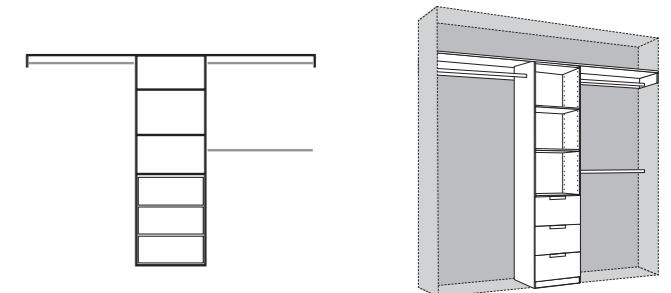

Suits openings 2100-2400mm

5

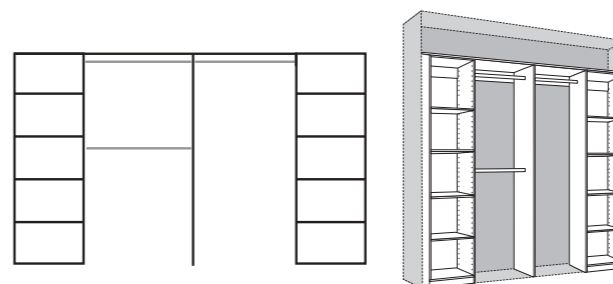

6

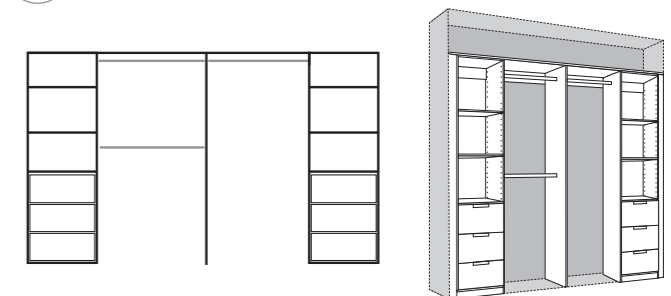

STEP 1

Assemble drawer/shelf units

Follow the instructions included with your cabinet unit/s

IMPORTANT

If you have nib walls, you may need to use the supplied infill panel to move the unit/s off the wall enough for the drawers to open freely. Attach the infill panel to the front of the unit gable using the white KD fittings.

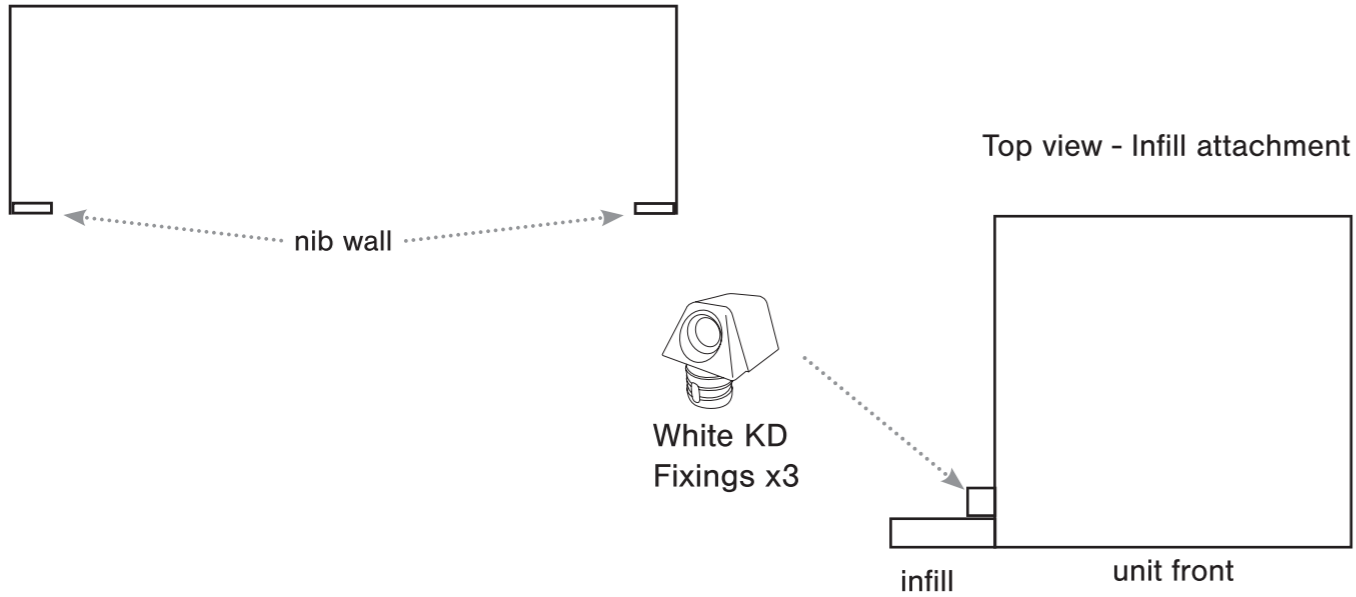

STEP 2

Place assembled unit/s into wardrobe

Place the cabinet unit/s into the wardrobe as per your configuration. Ensure they are sitting square. Do not fix in place yet..

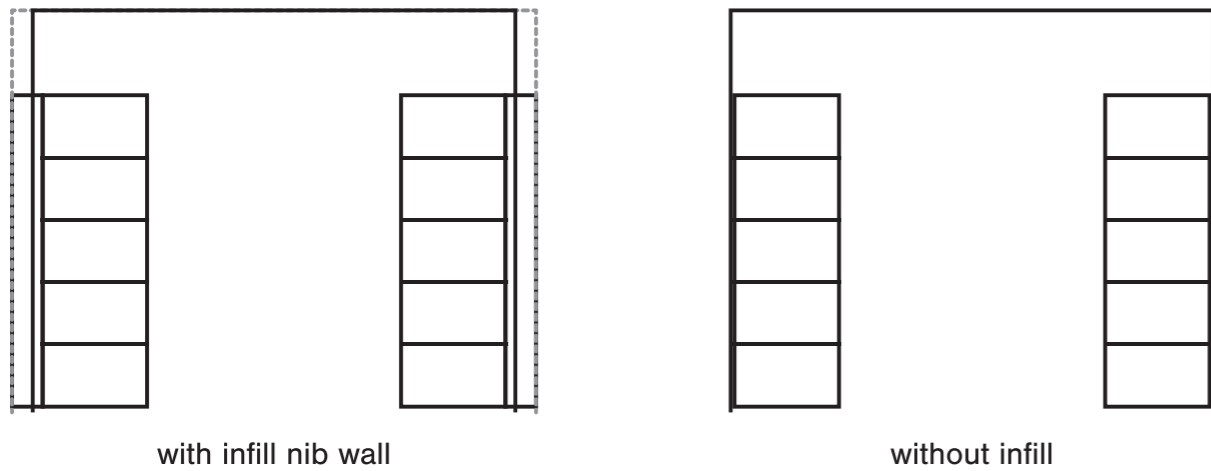

STEP 3

Measure wall batten(s) width and cut to size

Packages 1 & 2 Width (A) divide by two, minus 8mm = Width (B)

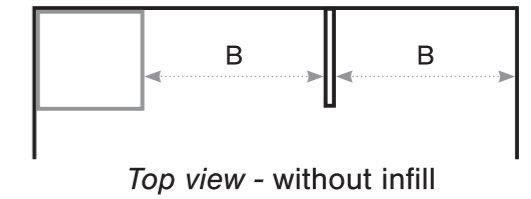
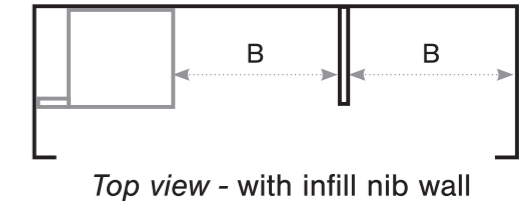
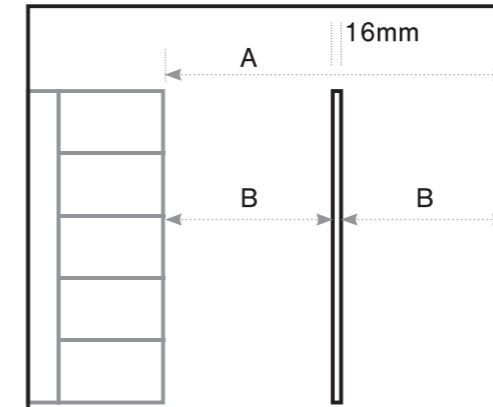

Packages 3 & 4

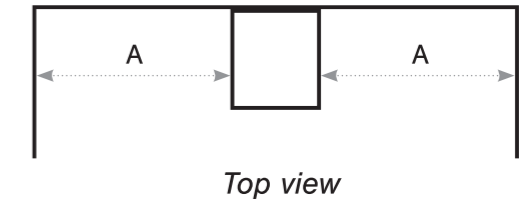
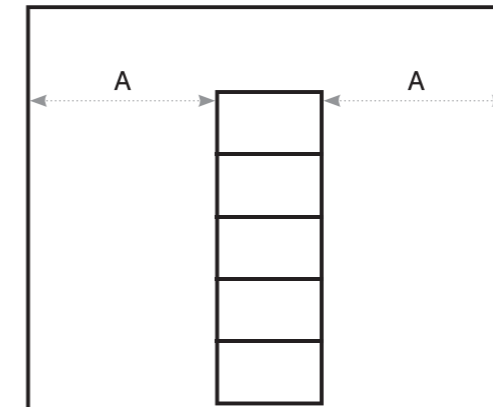

Packages 5 & 6 Width (A) divide by two, minus 8mm = Width (B)

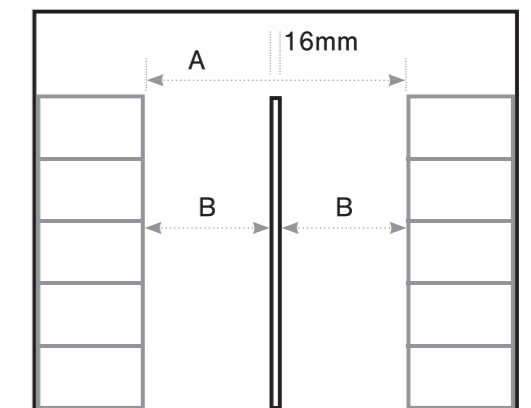
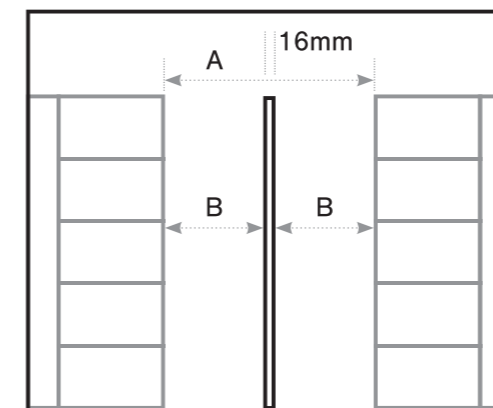

with infill nib wall

without infill

STEP 4

Mark the position of batten

Using a spirit level, mark a pencil line on the back wall from the top of the 2 units. For 1 unit, configurations mark along back wall to corner and around to the front of the wardrobe, approximately 450mm.

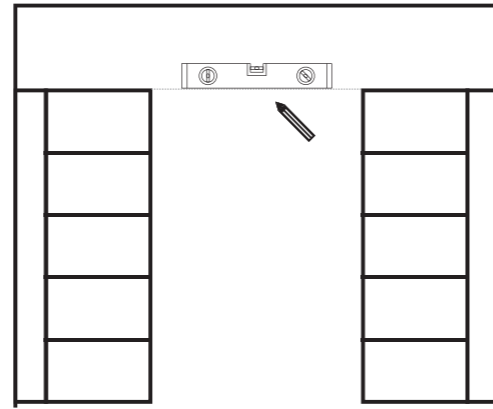

STEP 6

Measure and cut hat shelf to size

Measure the full length of the back wall and front of the tower units. Using your builders square, check the corners for square. Mark the hat shelf and cut it to size.

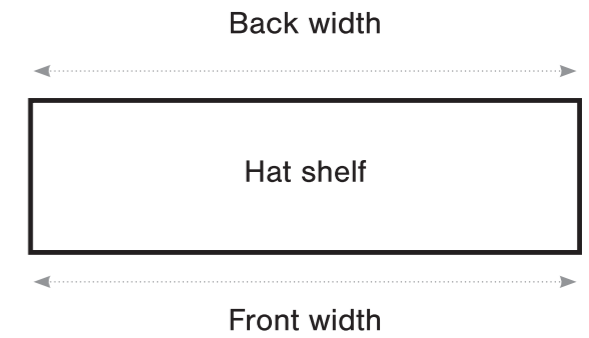

STEP 7

Place the hat shelf on the units and wall battens

Note – At this stage, depending on the internal height of your wardrobe. It may be necessary to remove 1 of the cabinet units to allow for the hat shelf to be installed.

Place the hat shelf on top of the cabinet unit, and battens; once you are happy with the fit, you can fix them in place.

If you removed a cabinet unit, place it back into the wardrobe, ensuring it sits square. Use your screw fixings, and secure the hat shelf to the cabinet unit, the back wall batten and side cleat.

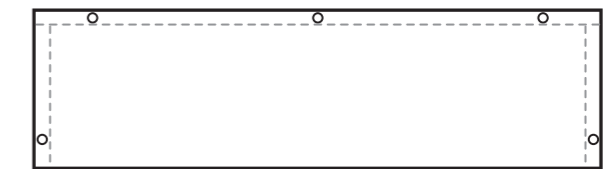
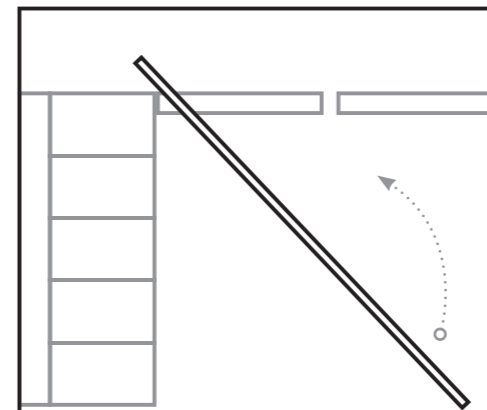

Top View - hat shelf fixings

STEP 8

Fitting divider

Packages 1 2 5 6

Attach the four KD fixings to the top and bottom of the divider. Place the divider under the hat shelf, and centre between the two back wall battens. Screw the divider to the underside of the hat shelf.

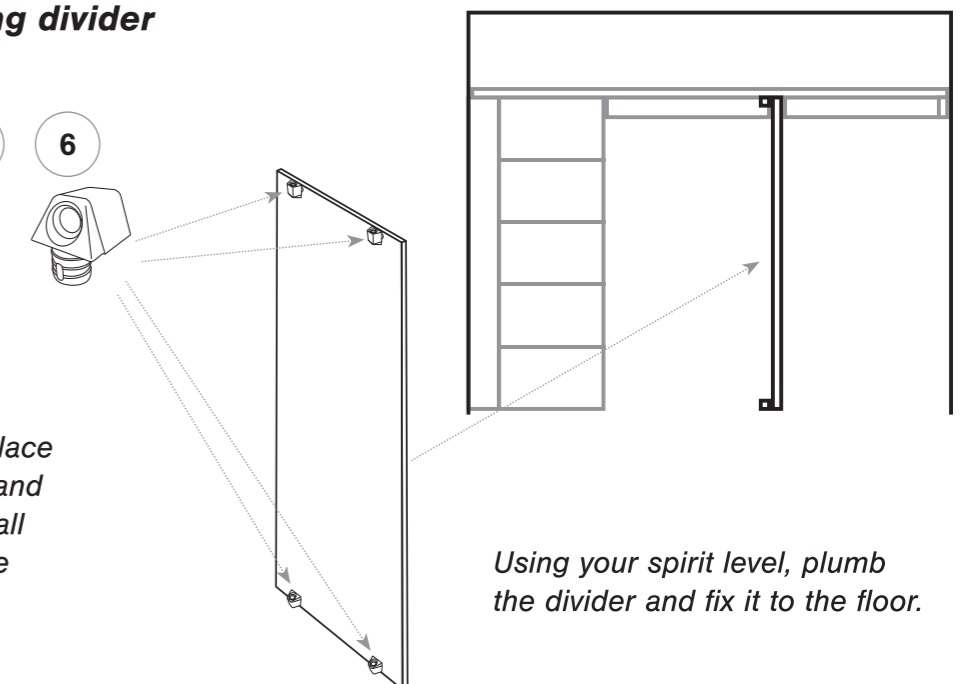

Using your spirit level, plumb the divider and fix it to the floor.

STEP 5

Fixing batten

Using a Stud finder, locate studs for fixing.

Note – if stud fixing points cannot be found you will have to use Wall Mate or Wall Plug fixings.

Align the wall batten with the pencil line marked on the back wall and fix it to the wall. Ensure the batten is aligned with the top of the tower unit(s). Fix the short cleat to the side wall if it is a single unit.

Note – if your wardrobe space has nib walls, insert the hat shelf, before fixing the side cleat.

Packages 1 & 2

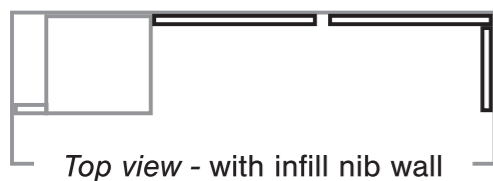

Top view - with infill nib wall

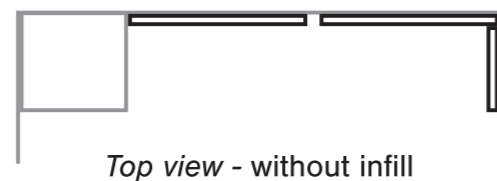

Top view - without infill

Packages 3 & 4

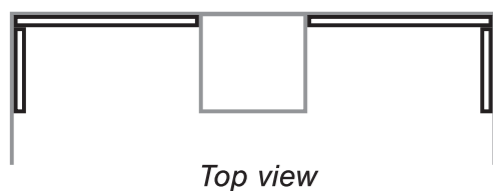

Top view

Packages 5 & 6

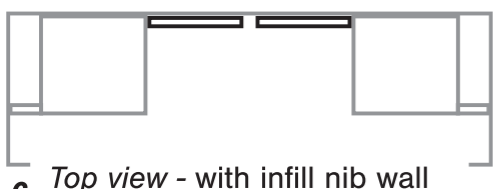

6 Top view - with infill nib wall

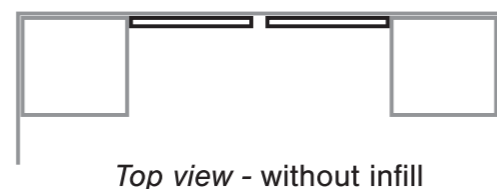

Top view - without infill

STEP 9

Cut and fit hanging rail/s

Measure the distance between the cabinet unit and the divider or wall. Deduct 6mm from the measurement to allow for the hangrail bracket. Cut rail/s to size.

Fix the flanges 35mm under the hat shelf. This will be your top fixing screw and 240mm from the back of the cabinet. Place the hanging rail into the hangrail brackets.

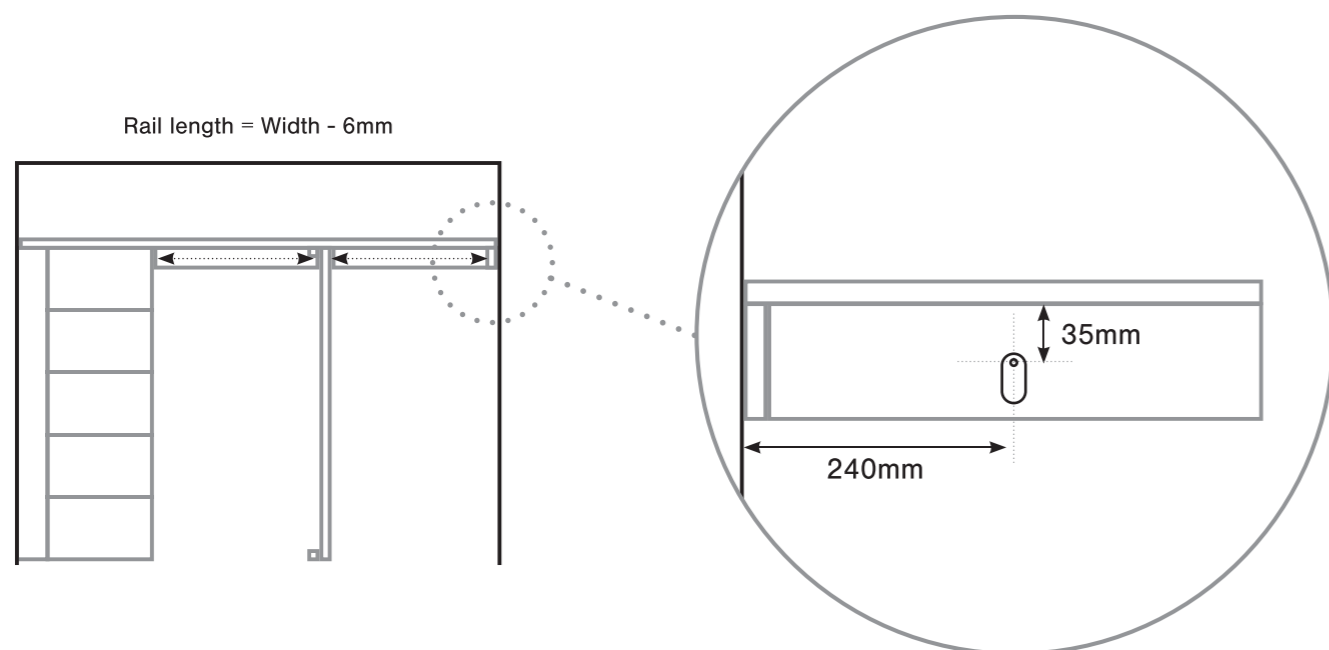

STEP 10

Replacing skirting

Measure between tower unit and divider and cut skirting to suit. Refix to wall.

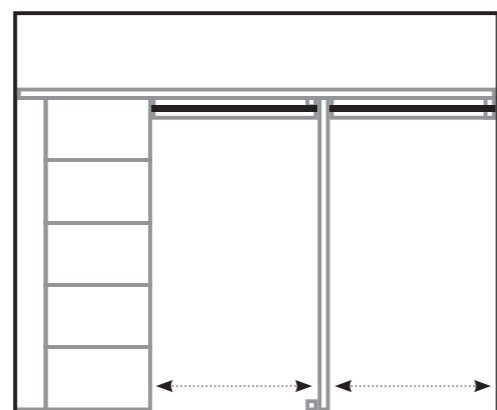

STEP 11

Cleaning and gap filling

Firstly, clean all surfaces with a suitable cleaner like Diggers Multi-Purpose Cleaner. Using a caulking gun, fill all gaps around the newly installed wardrobe. (See video for hints and tips)

TIP – Use a spray bottle to spray a small amount of soapy water onto the recently applied gap filler. This will make it much easier to wipe down and clean off any excess filler.

LUGNA

FORM & FUNCTION

CABINET CARE INSTRUCTIONS

Everyday care for your cabinets:

Liquid spills should be cleaned up as they occur. Liquids and other damp objects, i.e. towels, will eventually cause permanent damage should they be left unattended.

Everyday clean-up of cabinets can be done with a damp cloth and a dry cloth. Ensure you use a clean cloth every time when wiping down your cabinets, as foreign dirt, grease, and oils may inadvertently be transferred to the surface.

Cleaning melamine products:

Oils, grease, and other soils that do not respond to water can be removed with a solution of mild soap and water. The surface should be rinsed immediately with a clean, damp cloth and dried thoroughly with a soft cloth to avoid streaking or moisture seeping into the seams around the edges.

PLEASE NOTE: Never use abrasive cleaners, ammonia, bleaching agents, scouring pads or powdered cleaners on any type of cabinetry.

Cleaning cabinet hardware:

Brass and Silver cleaners are not recommended for cleaning handles. Some of these cleaning solutions contain harsh chemicals that may damage the finish on your handles.

Wash your hardware with a solution of warm water and a small amount of mild dish detergent. Dry your hardware and areas around the cleaned area immediately.

Hinges can be cleaned with a dry cloth or cotton-tipped swab.